

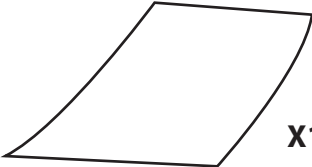

OPBOUW VAN DE MAQUETTE VAN HET VOORMALIGE PALEIS VAN BRUSSEL HET COUDENBERG PALEIS

Benodigdheden

 <p>X19</p>	 <p>X1</p>	 <p>X1</p>	 <p>X1</p>
<p>19 vellen A4 papier waarvan 2 stevige vellen voor het plan</p>	<p>1 schaar</p>	<p>lijm en/of kleefband</p>	

Handleiding

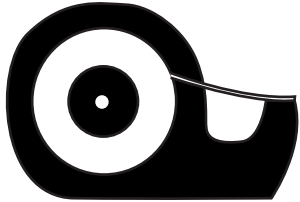
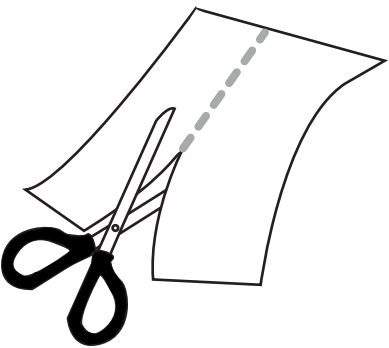
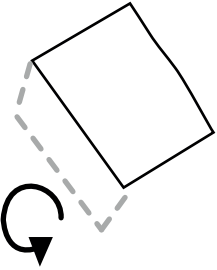
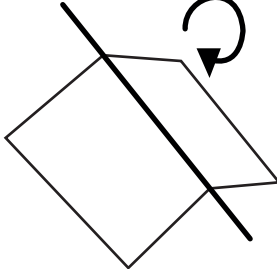
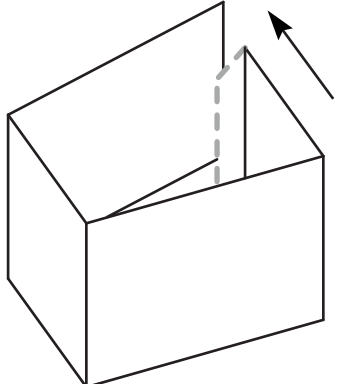
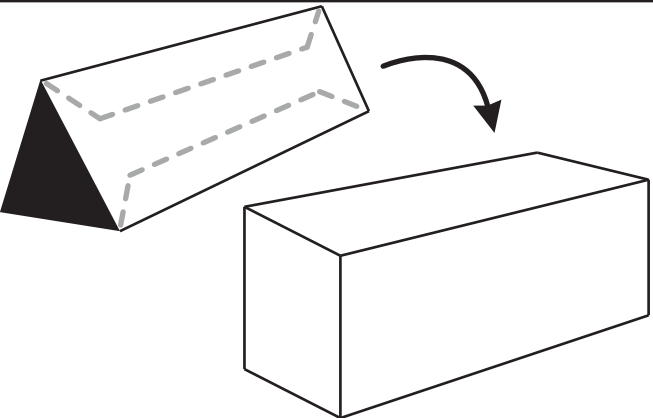
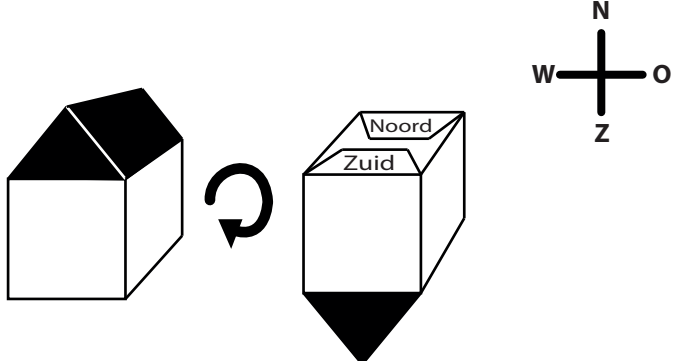
			
<p>1. Knip langsheen de stippellijnen.</p>	<p>2. Vouw de luikjes.</p>	<p>3. Vouw langsheen de lijnen.</p>	<p>4. Plak de luikjes vast om de gebouwen te sluiten.</p>
			
<p>5. Plak de daken vast op de gebouwen.</p>		<p>6. Plaats de gebouwen op het plan volgens de richtlijnen en plak ze vast.</p>	

0. PLAN

PARKEN EN

2. KAPEL
(sacristie)

2. KAPEL

3. WOONGEDEELTE (hoofddeel)

3. WOON-
GEDEELTE
(bijlage 1)

ISABELLA STRAAT

VOORPLEIN

1. AULA MAGNA

1. AULA MAGNA
(toren)

4. INGANGSPORTAAL (hoofddeel)

4. INGANGS

BALIEN

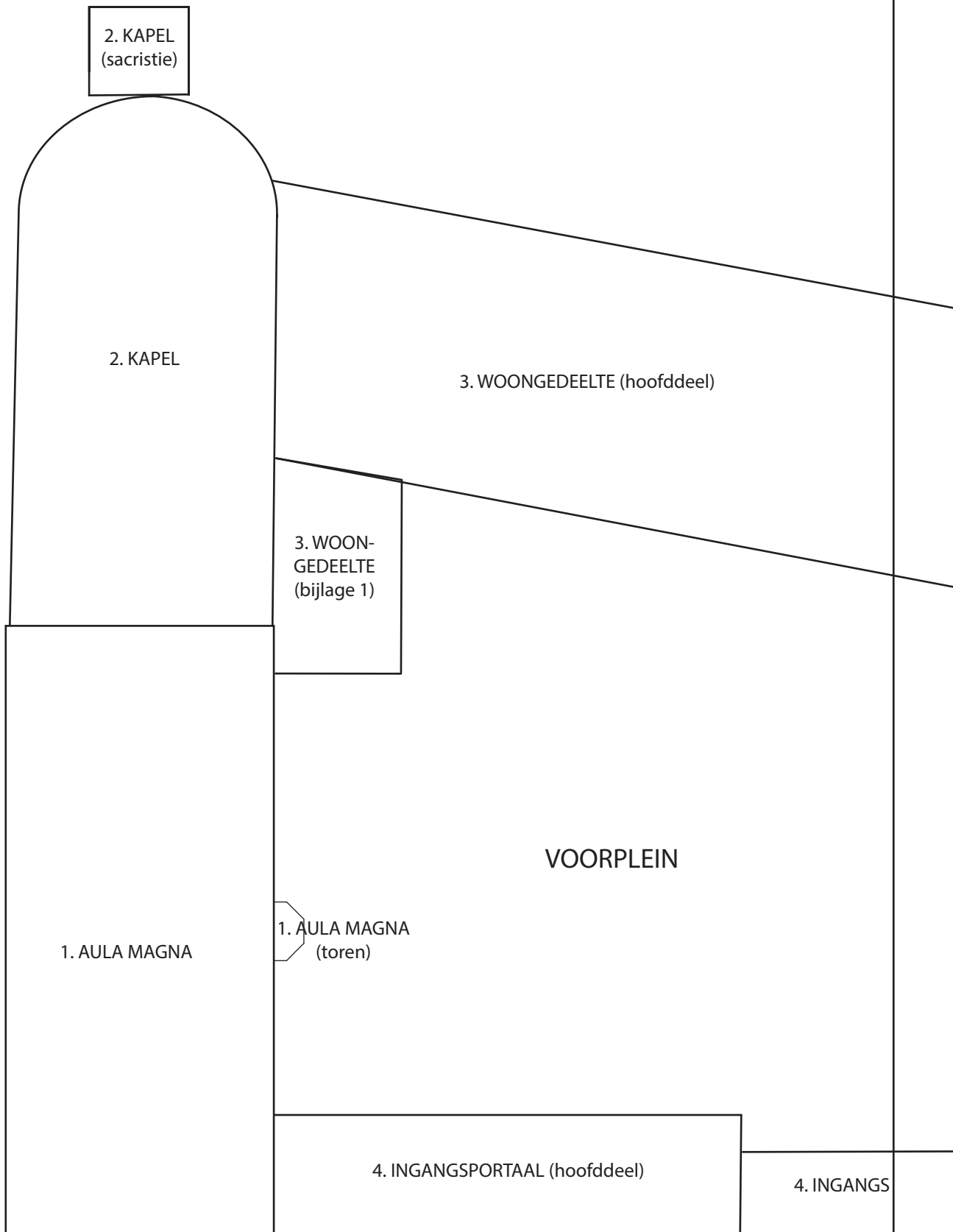

TUINEN

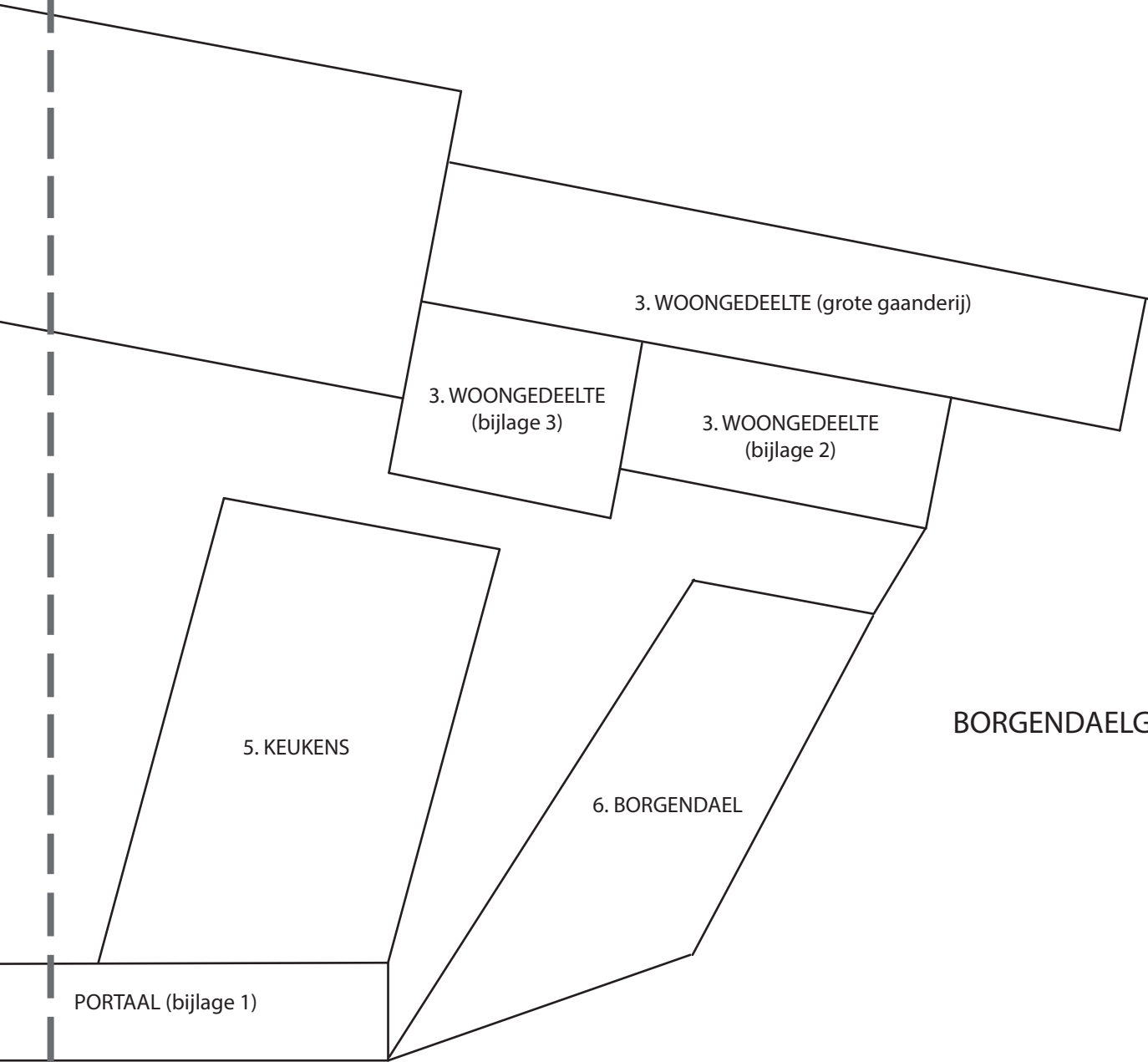
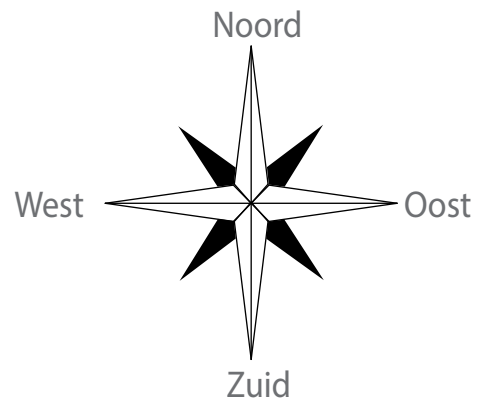

BORGENDAELGANG

PLEIN

Handleiding voor opbouw van de Aula Magna

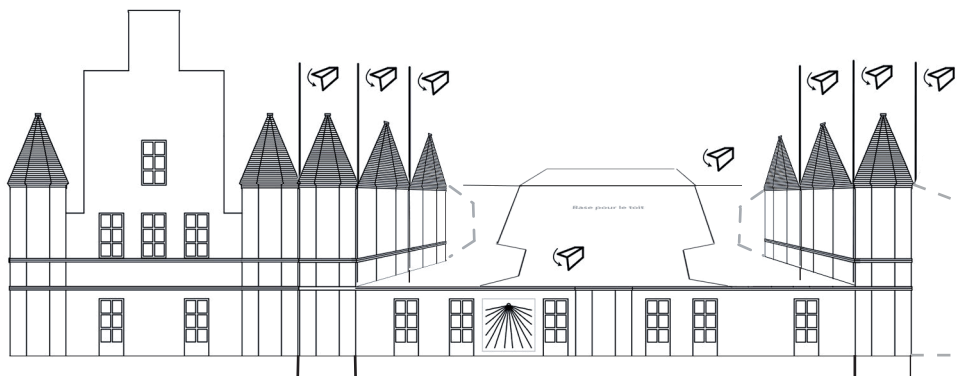
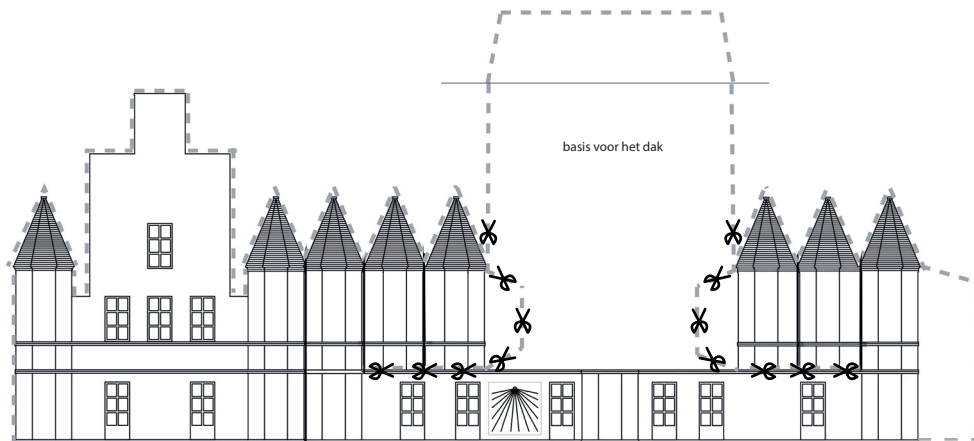

1. Knip langsheen de stippellijnen.

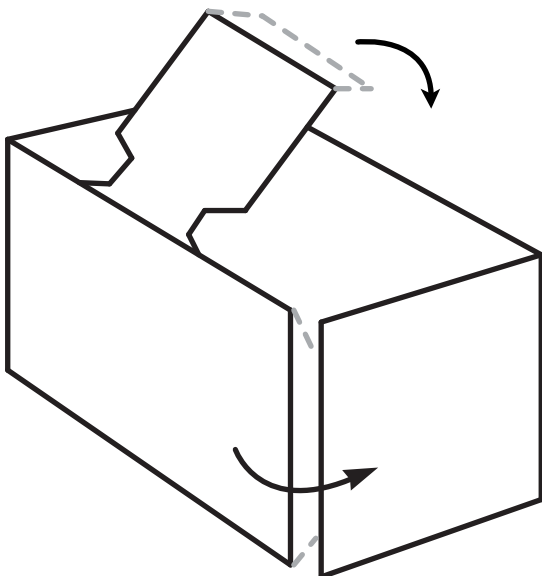

2. Sluit het gebouw: plak de twee delen aanen, plooi de basis van het dak en plak het luikje vast.

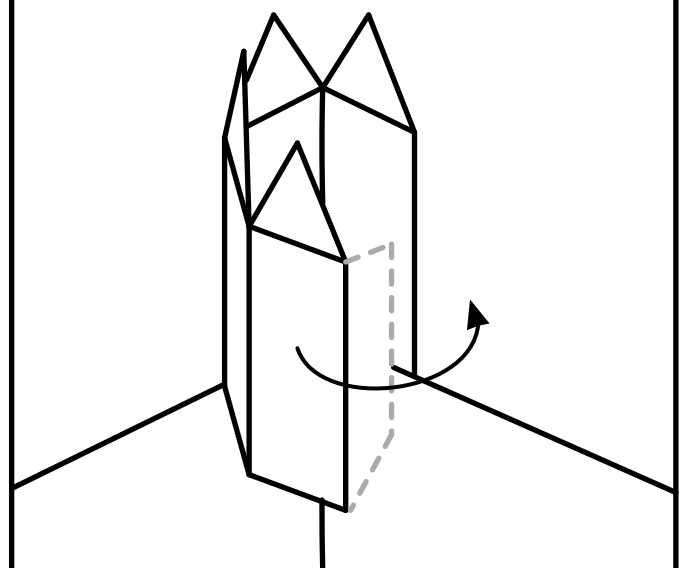

3. Vouw de zijden van de torentjes en plak het luikje vast.

1. AULA MAGNA

1.1 Gebouw

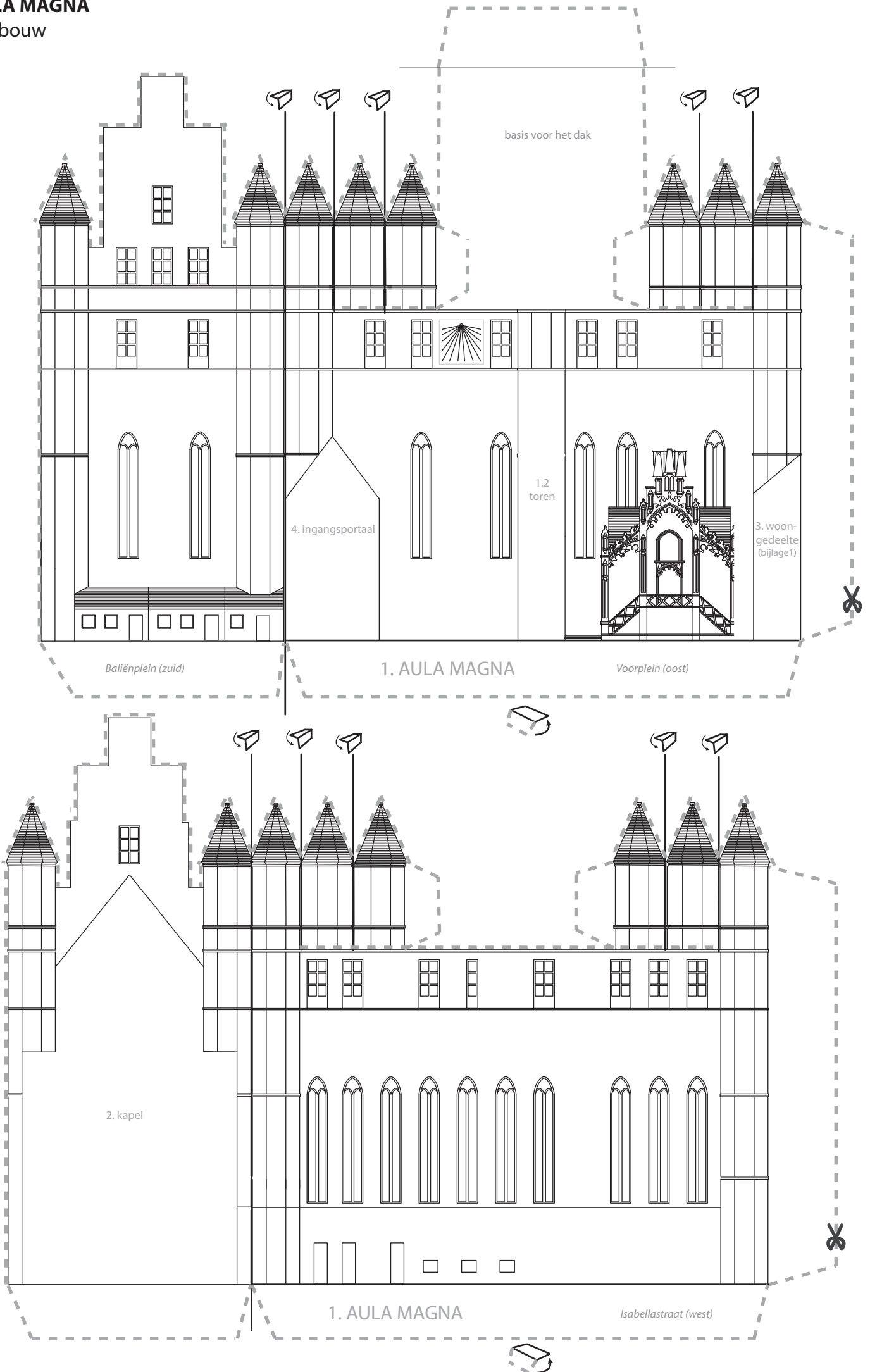

1. AULA MAGNA

1.2 Toren

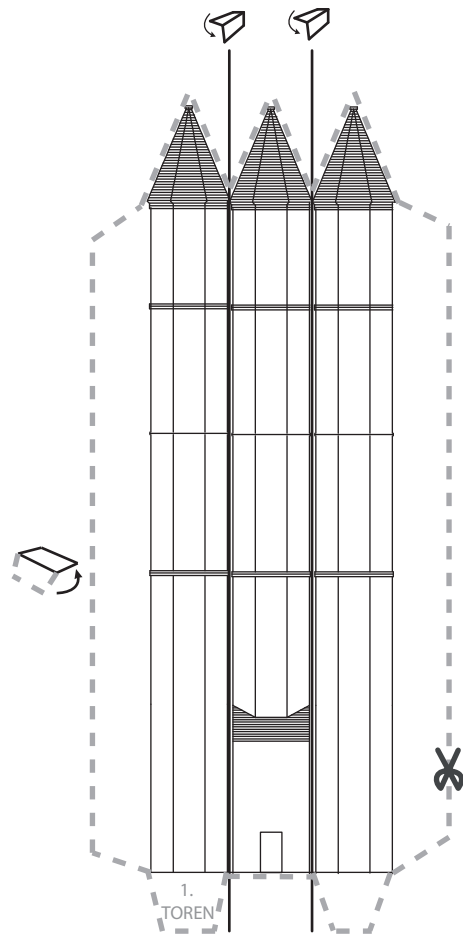

1.3 Dak

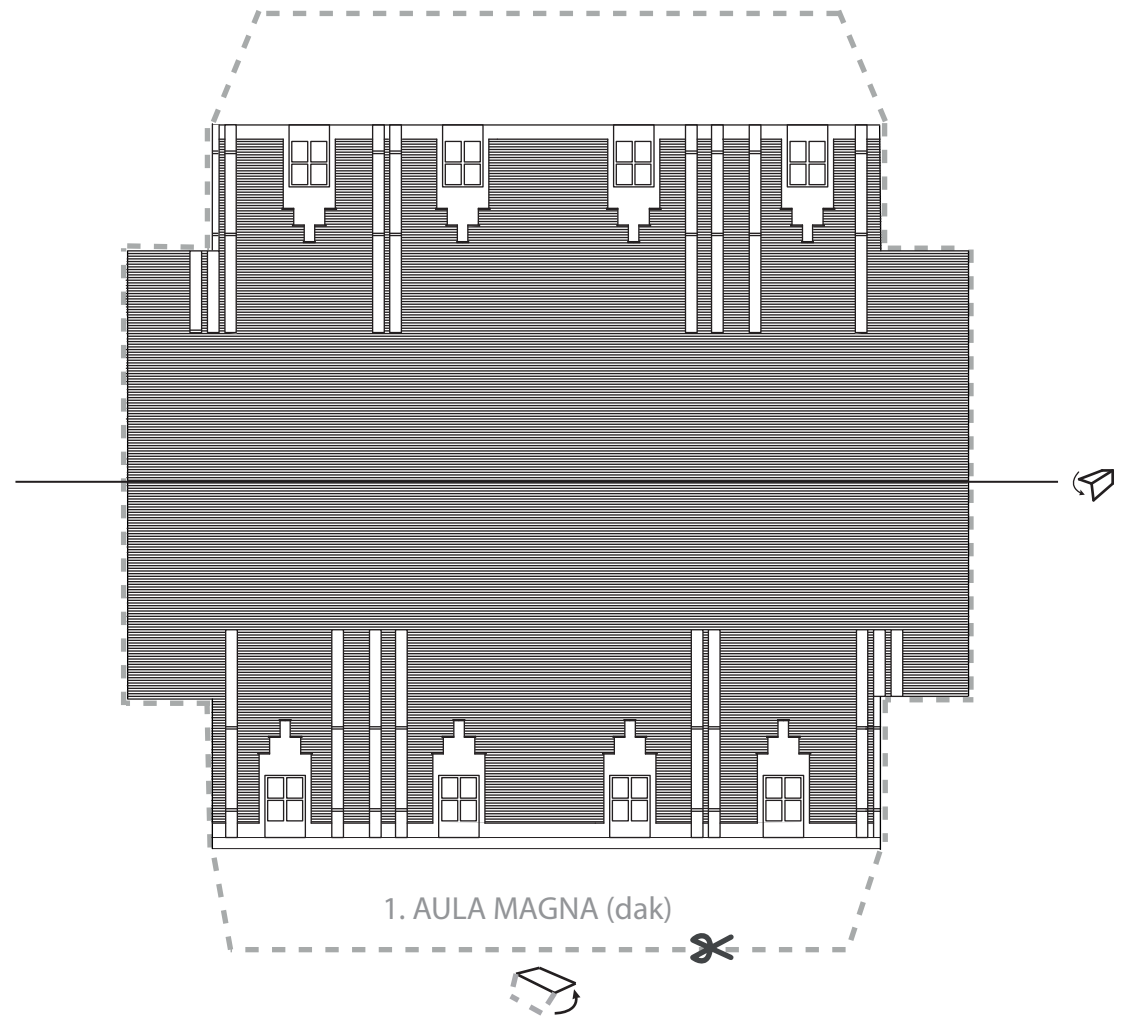

2.2 Gebouw (1^{ste} verd.)

2. KAPEL

2.1 Gebouw (gelijkvloer)

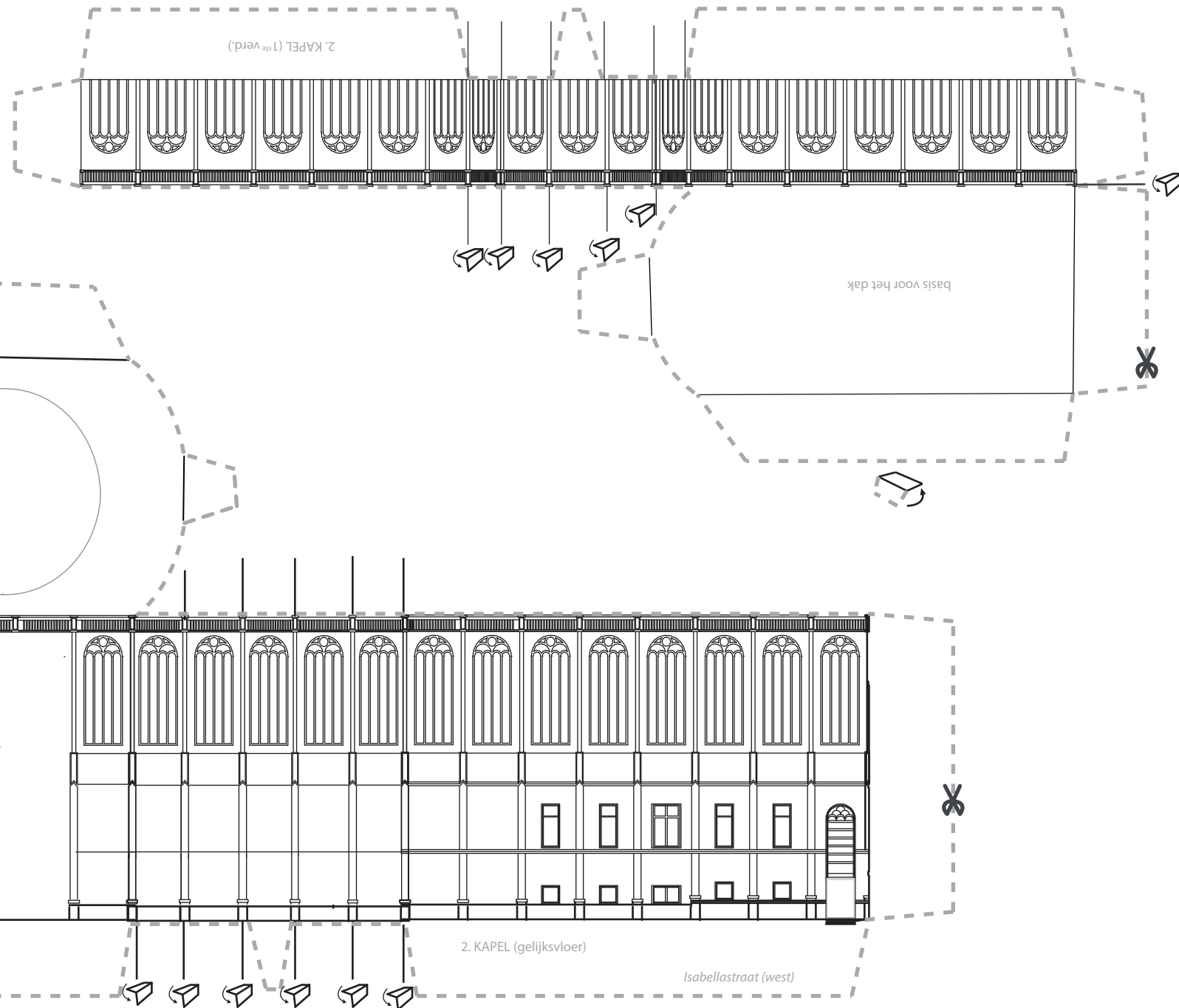

Handleiding voor de montage van het dak van de kapel

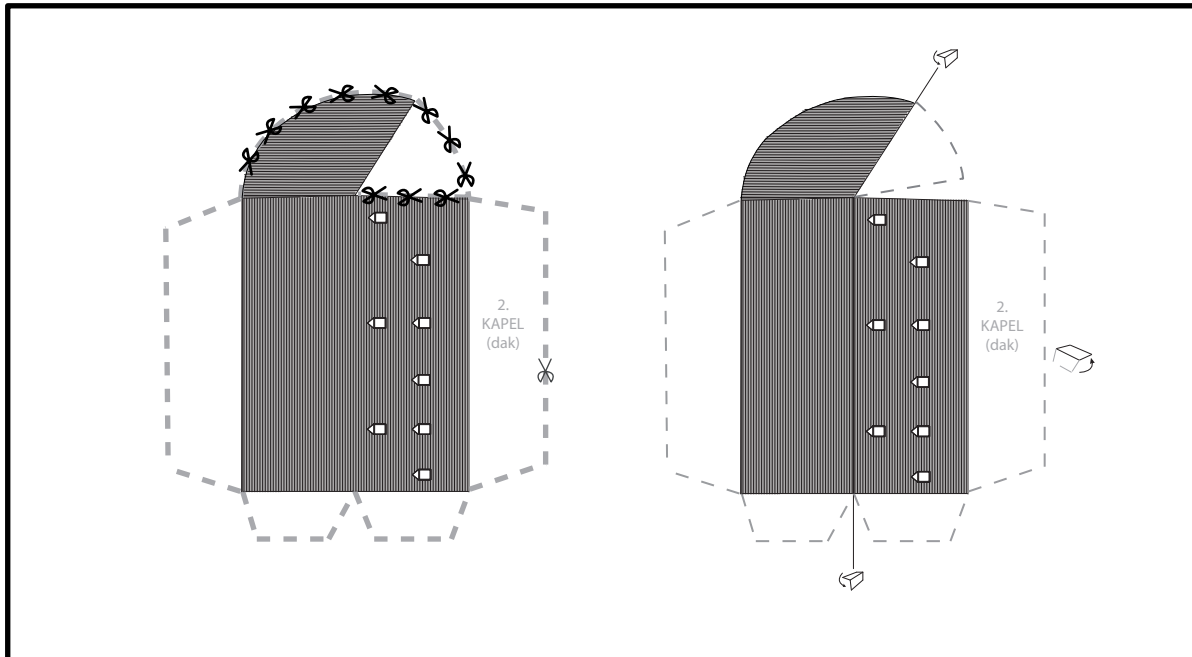

1. Knip langsheen de stippellijnen.

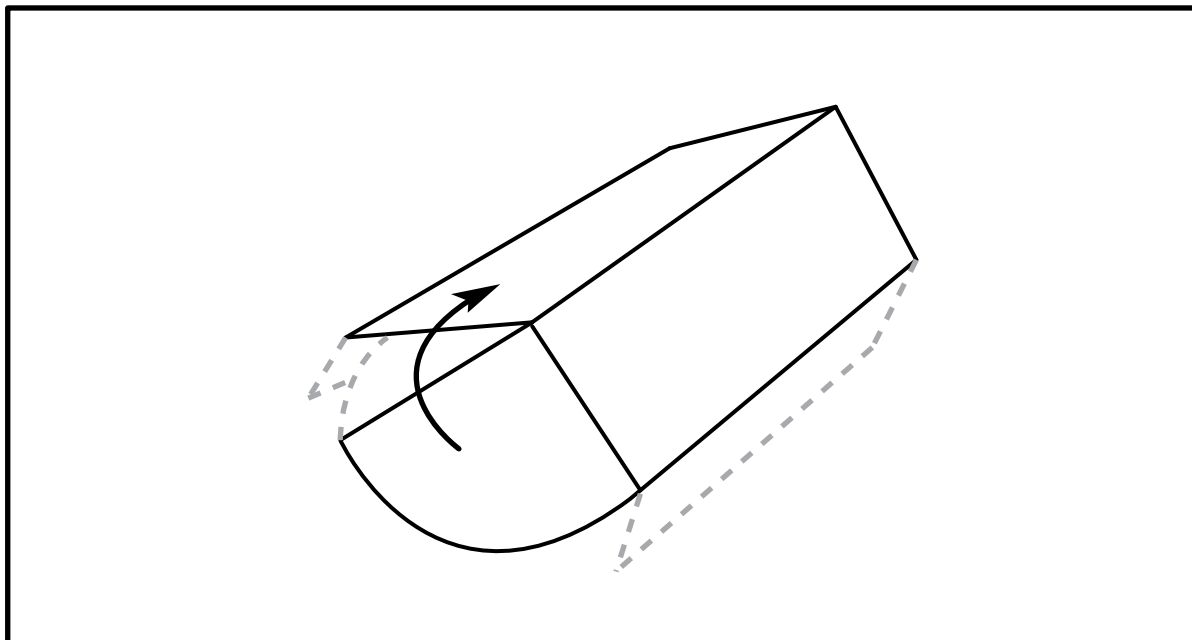

2. Vouw het dak en de afronding langsheen de lijn.
Plak het luikje vast aan het hoofdgedeelte van het dak om de afronding te kunnen sluiten.

2. KAPEL

2.3 Dak

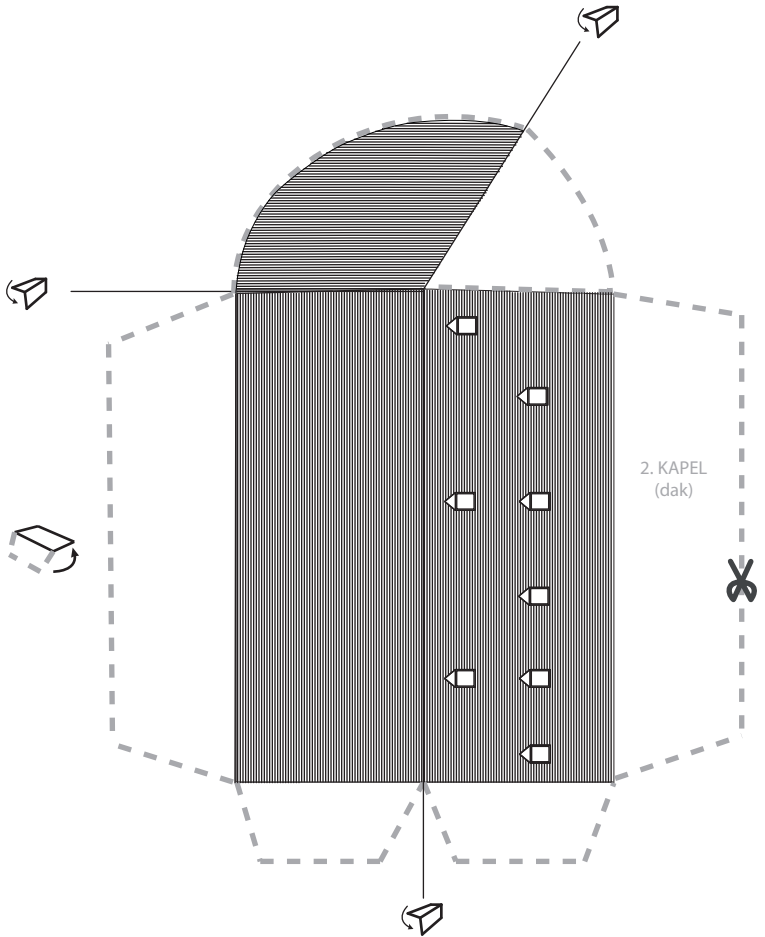

Handleiding voor de montage van de piramidevormige daken

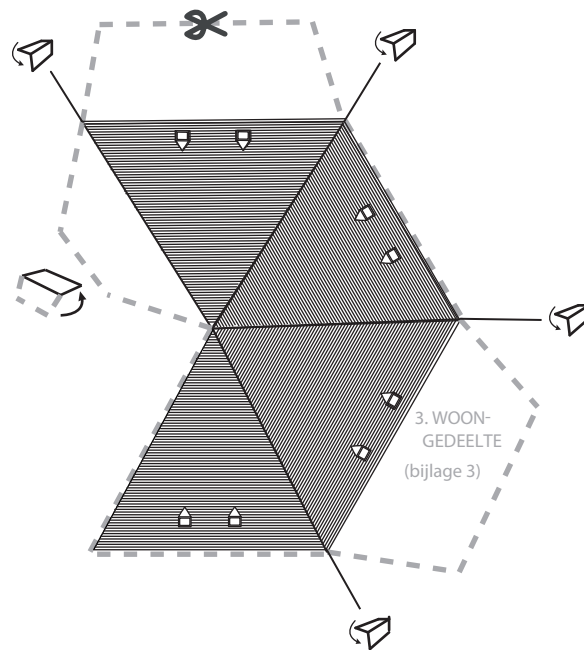

1. Knip langsheen de stippellijnen.

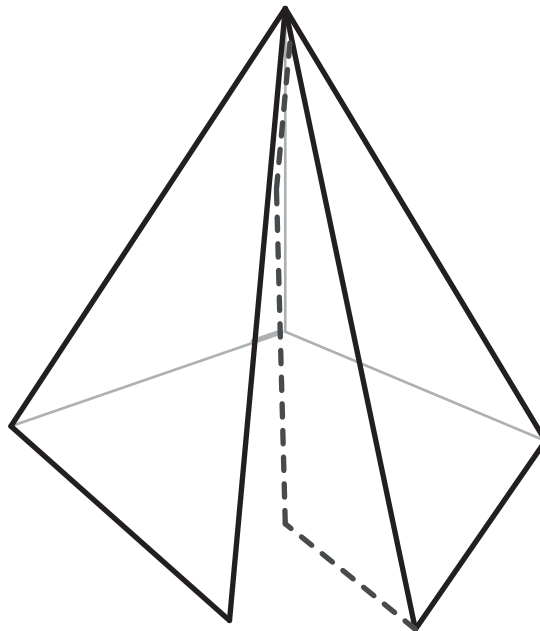

2. Plooi de vier zijden van de piramide en plak het luik vast.

2.5 Sacristie (dak)

2. KAPEL

2.4 Sacristie (gebouw)

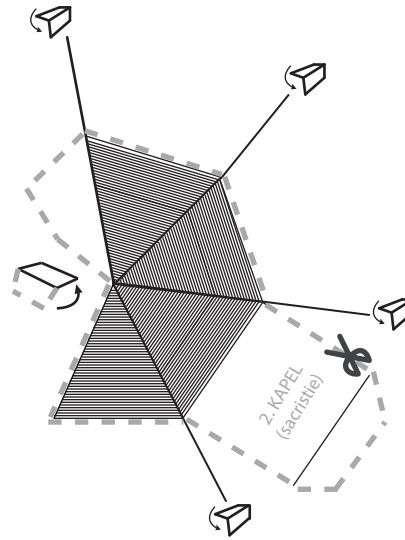
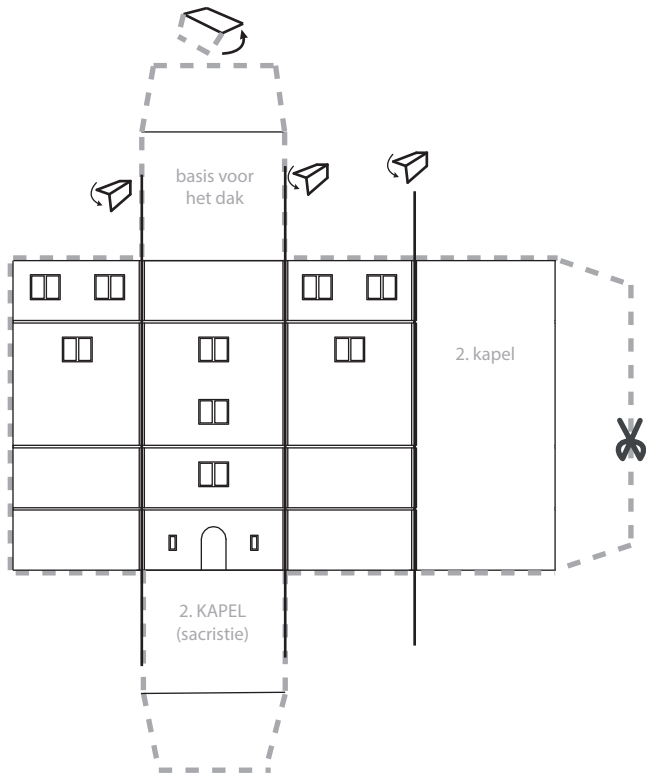

3. WOONGEDEELTE

3.1 Bijlage 1 (gebouw)

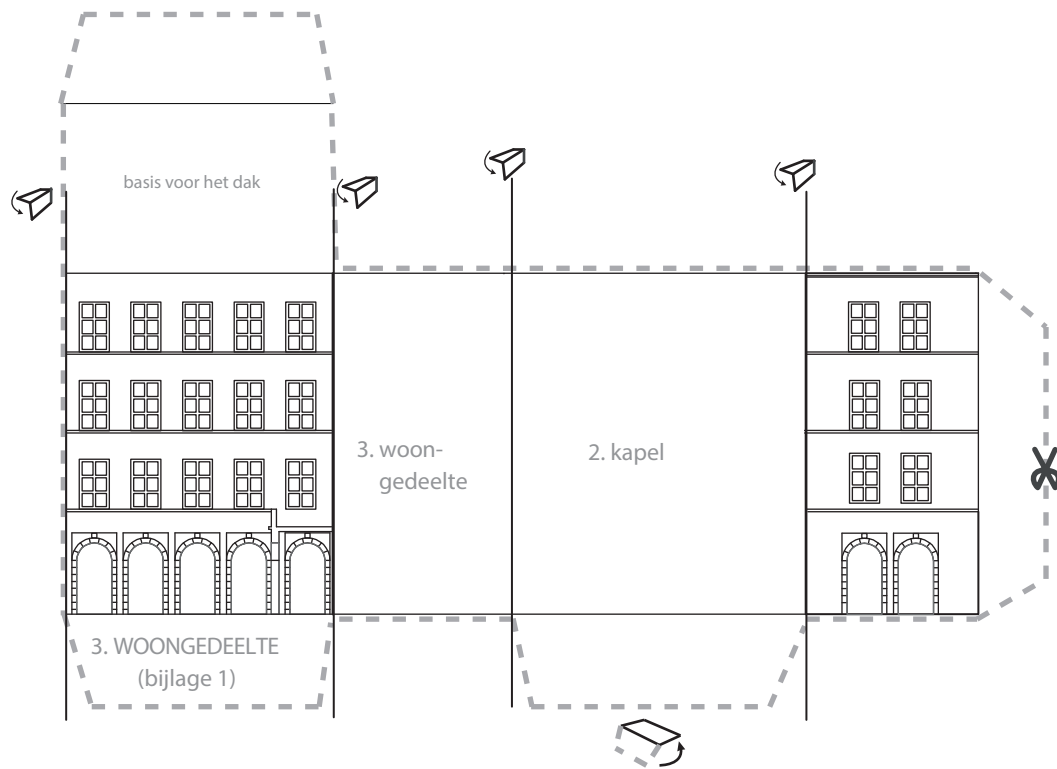

3.2 Bijlage 1 (dak)

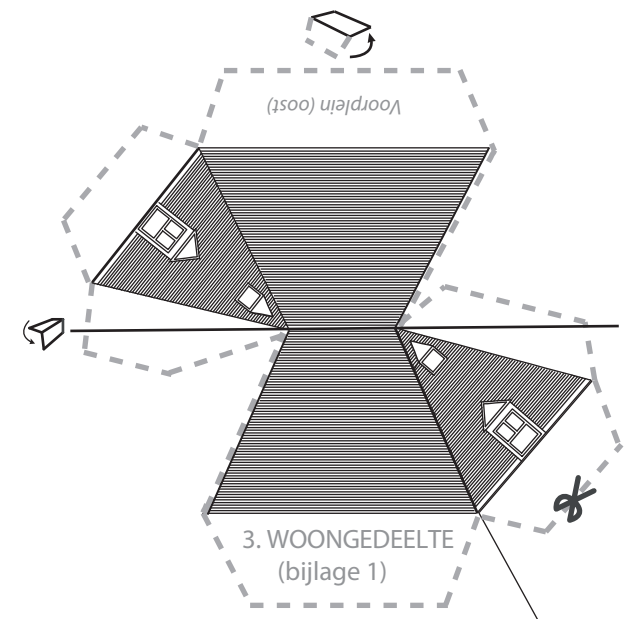

3. WOONGEDELTE

3.3 Hoofdgebouw (gebouw)

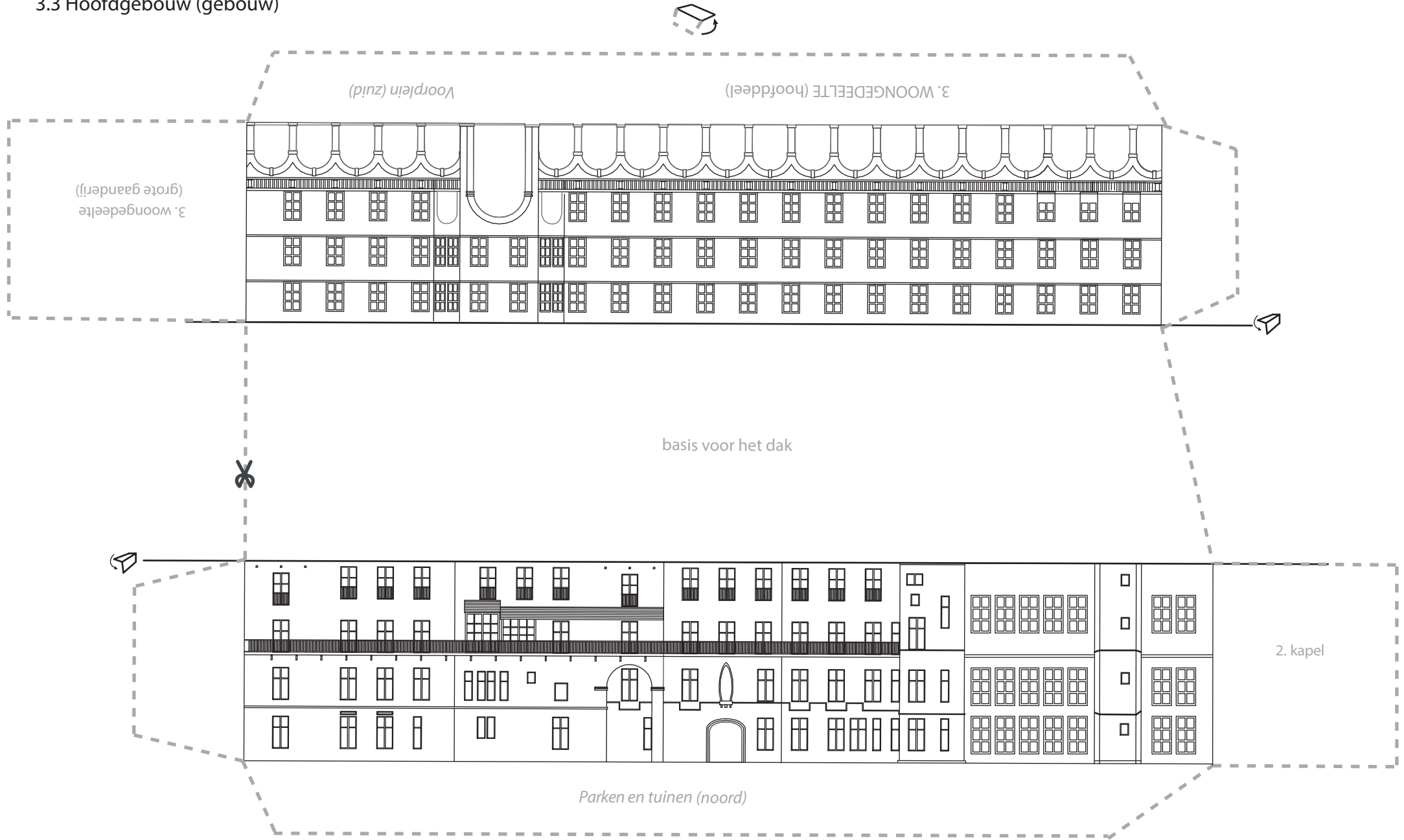

3. WOONGEDELTE

3.4 Hoofddeel (dak)

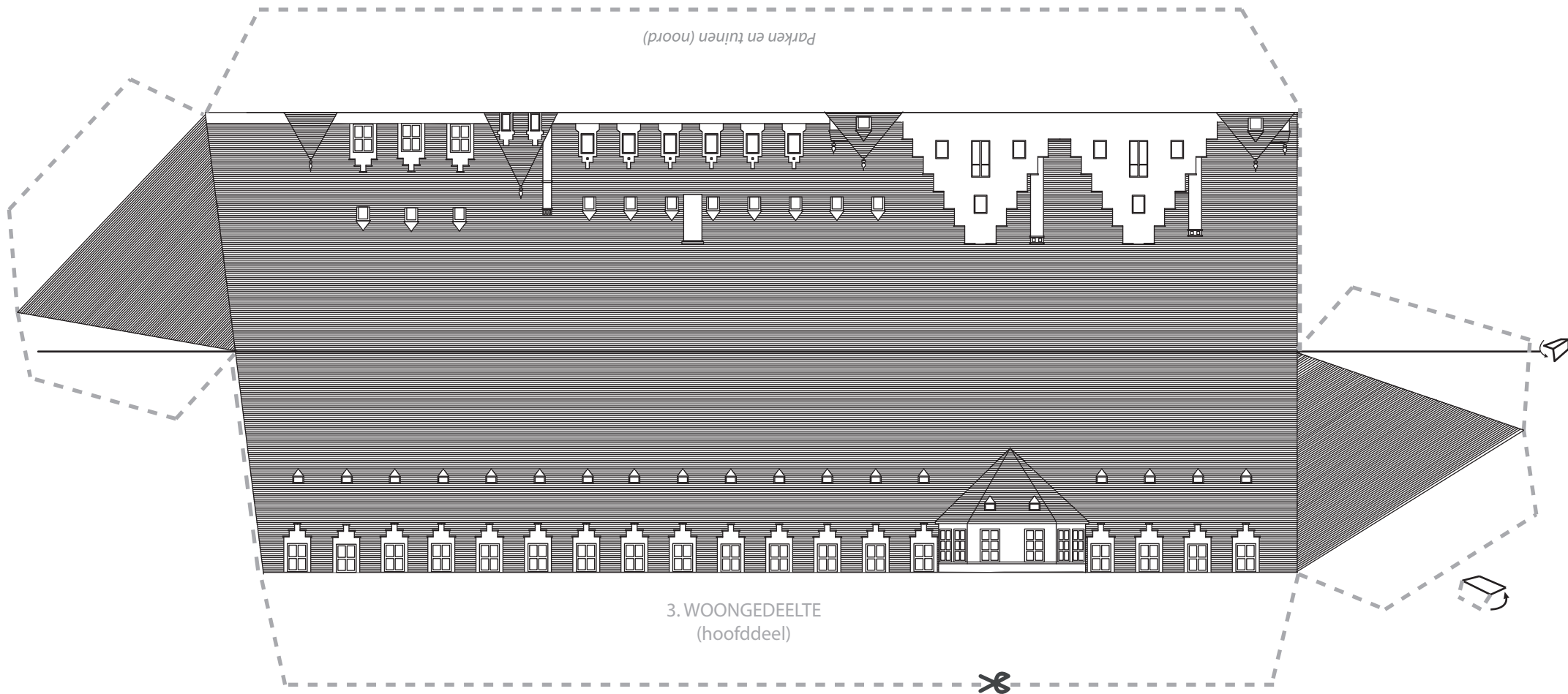

3. WOONGEDELTE

3.5 Grote gaanderij (dak)

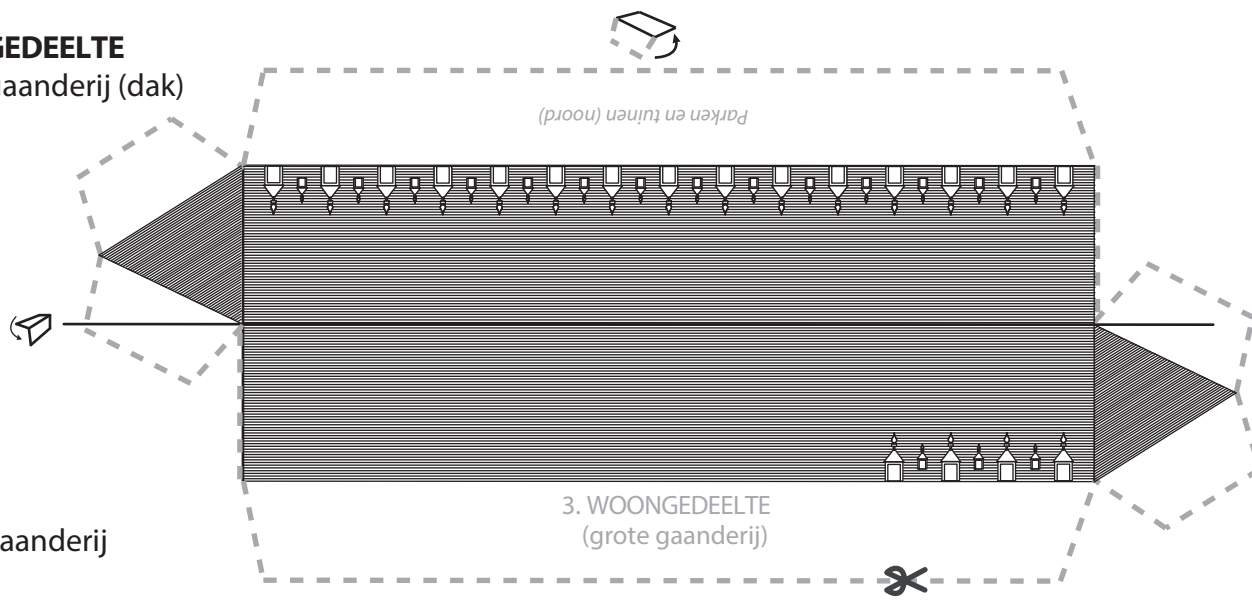

3.6 Grote gaanderij (gebouw)

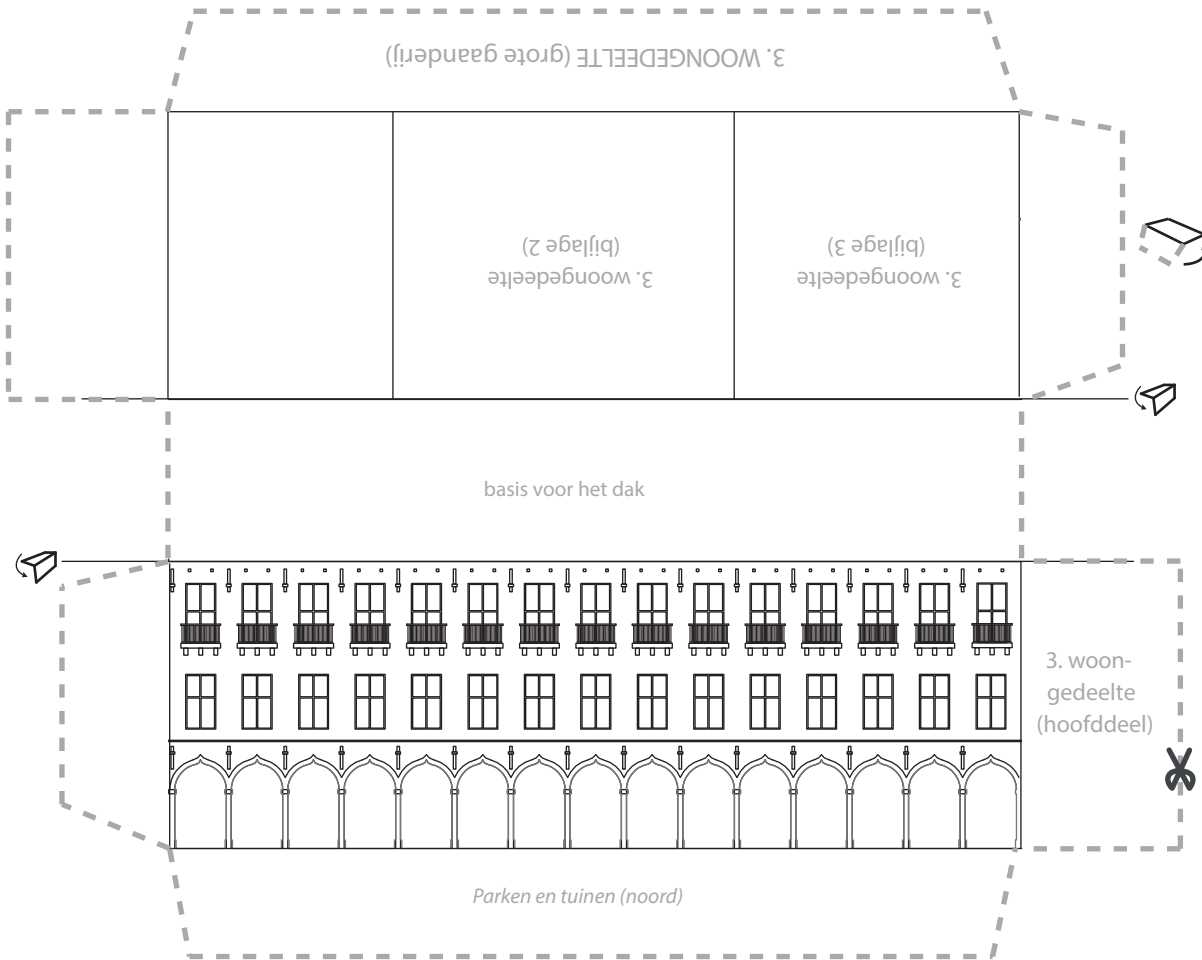

3.7 Bijlage 2 (dak)

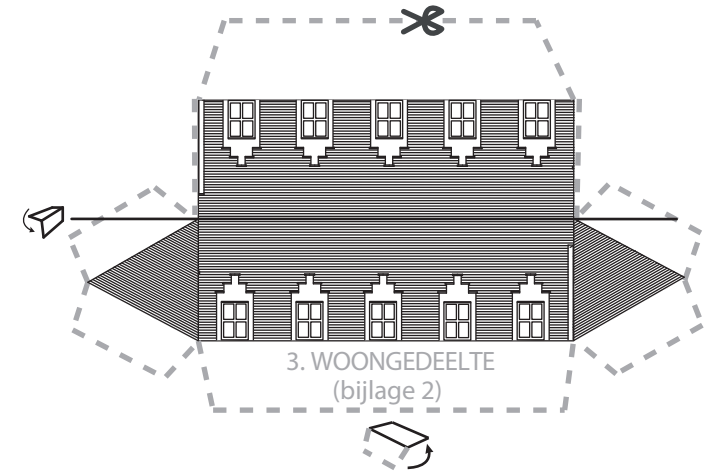

3.8 Bijlage 2 (gebouw)

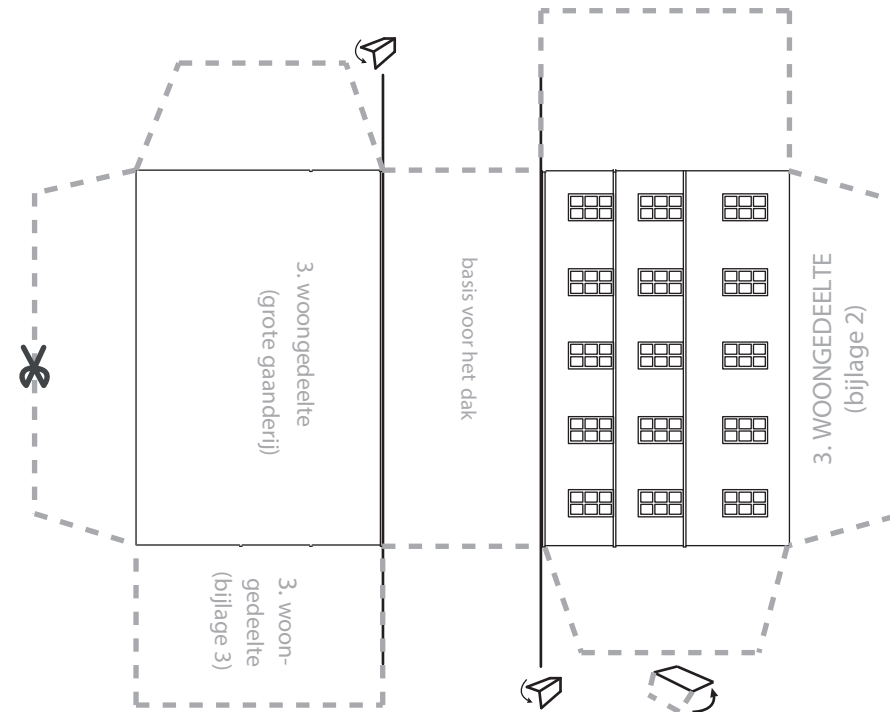

3. WOONGEDELTE

3.9 Bijlage 3 (gebouw)

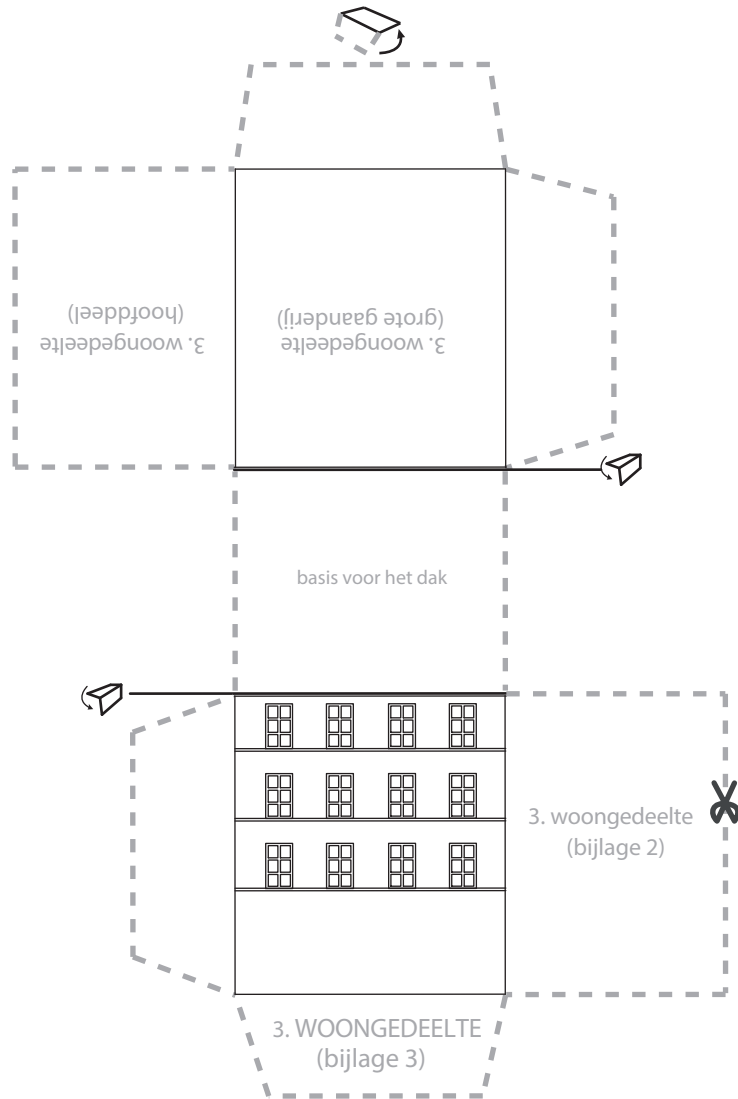

3.10 Bijlage 3 (dak)

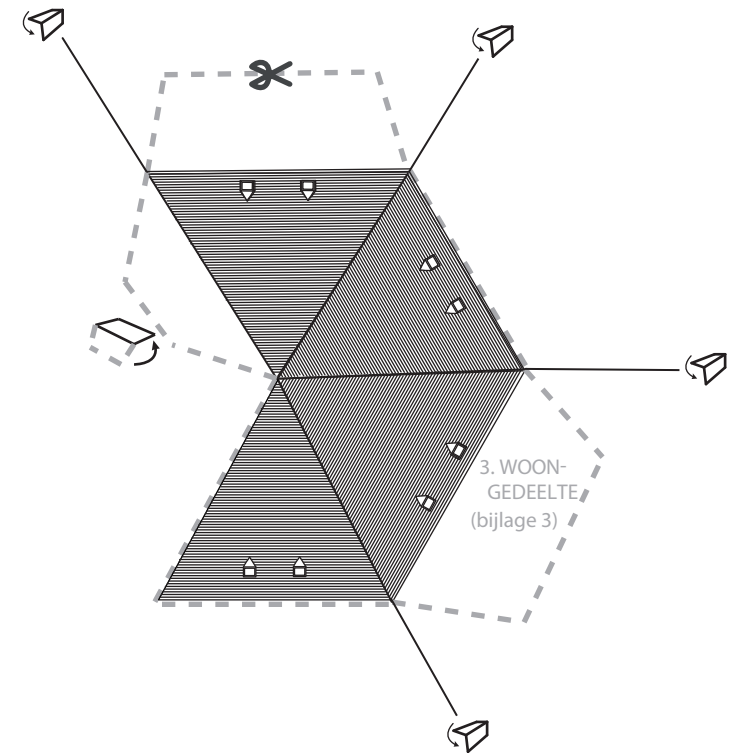

4. INGANGSPORTAAL

4.1 Hoofddeel (gelijkvloer)

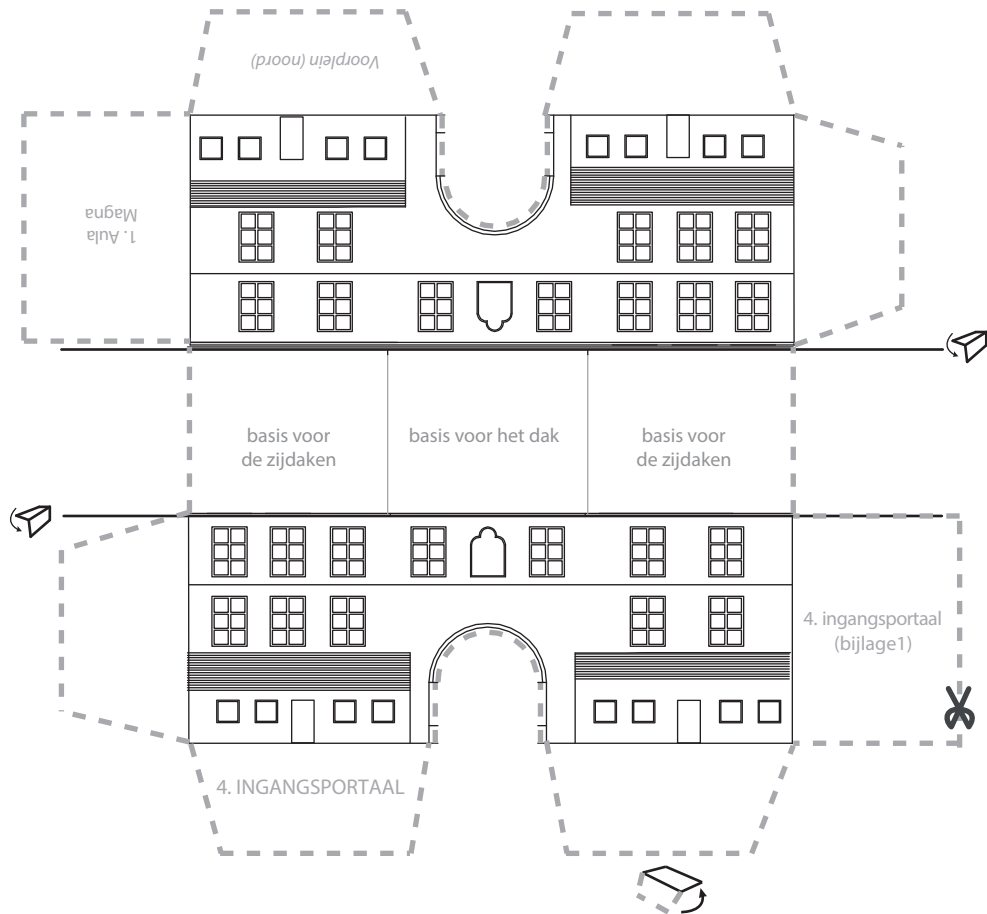

4.2 Hoofddeel (toren)

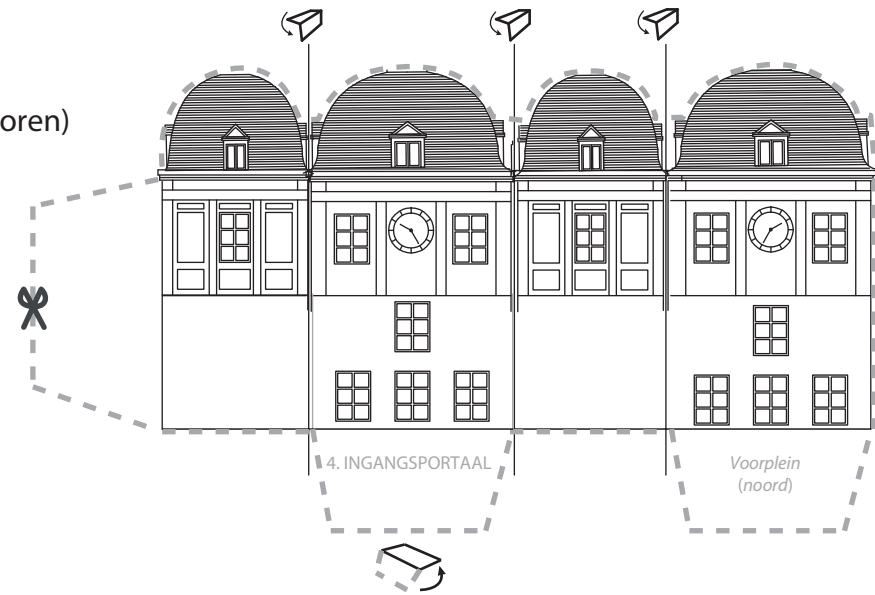

4.3 Hoofddeel (zijdaken)

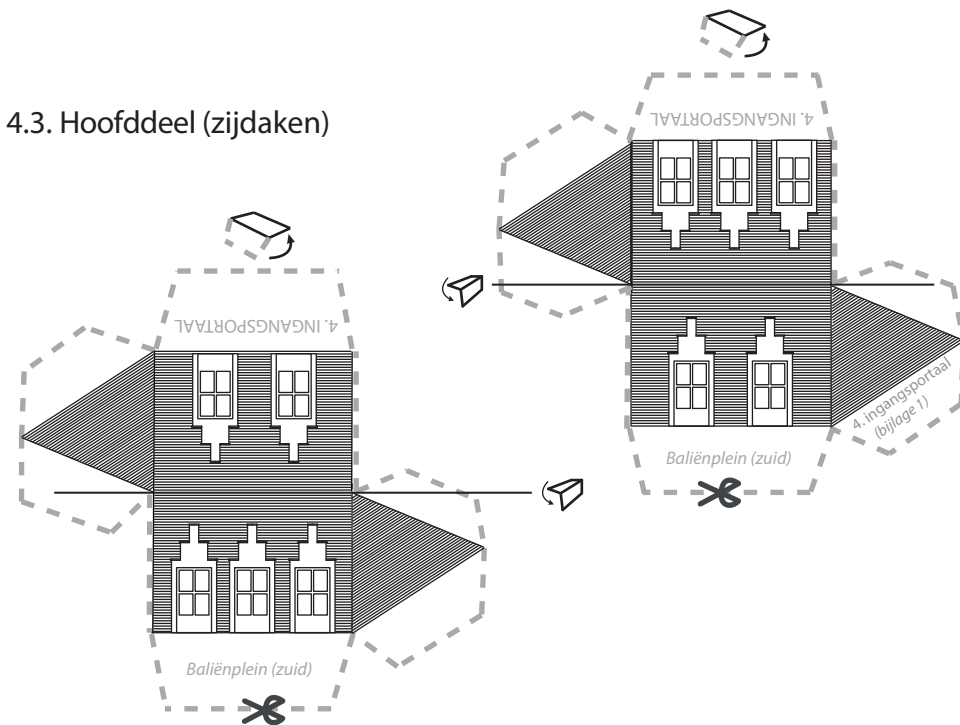

4. INGANGSPORTAAL

4.4 Bijlage 1 (dak)

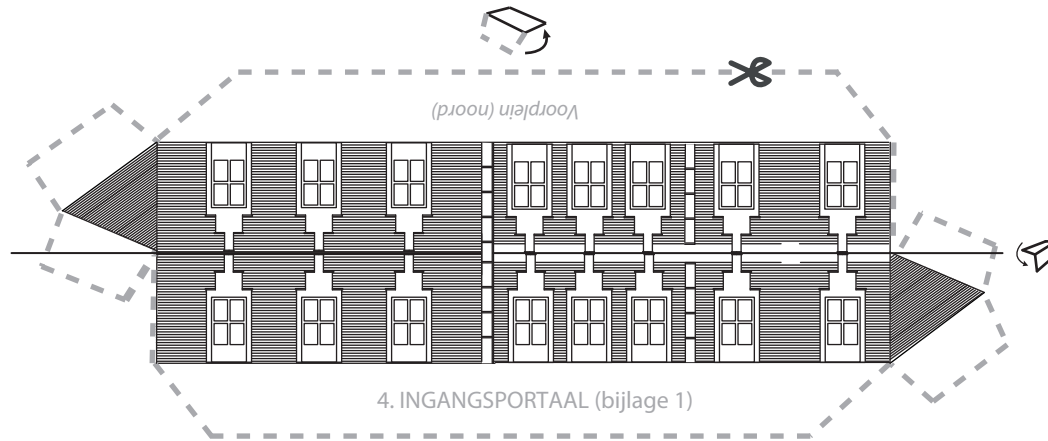

4.5 Bijlage 1 (gebouw)

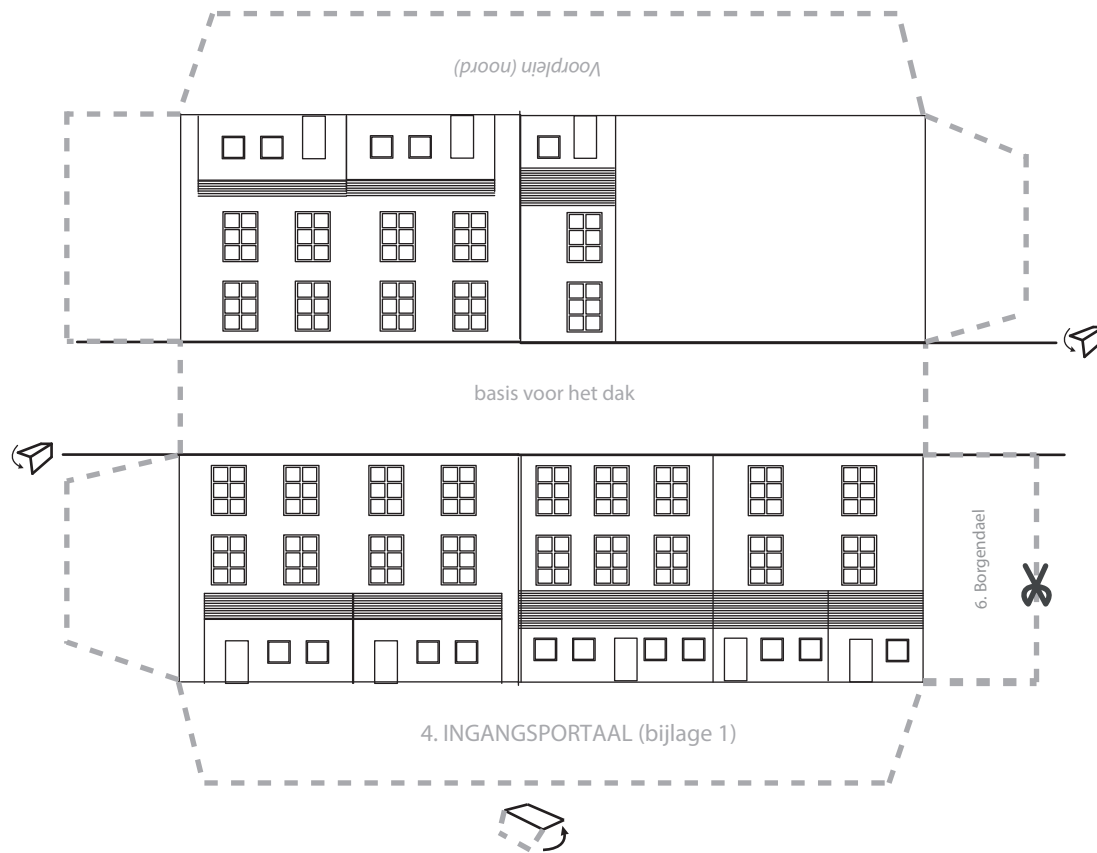

5. KEUKENS

5.1 Gebouw

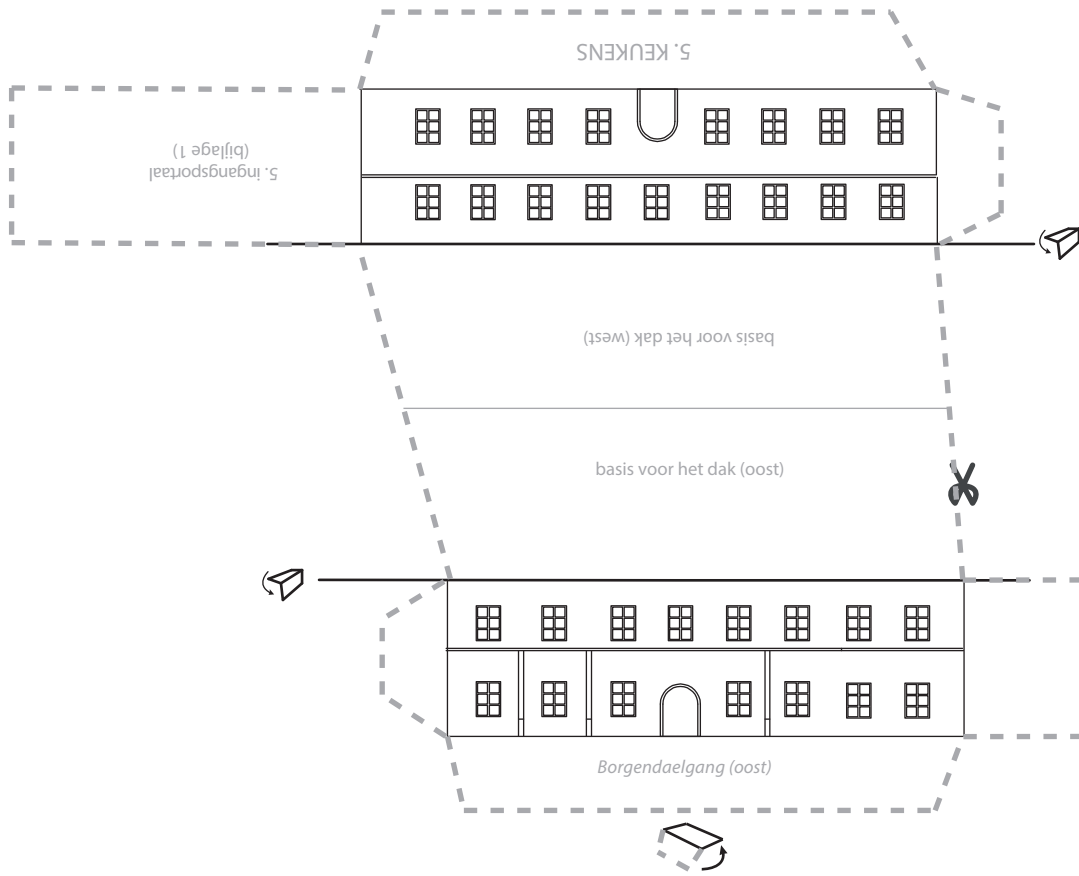

5.2 Dak (oost)

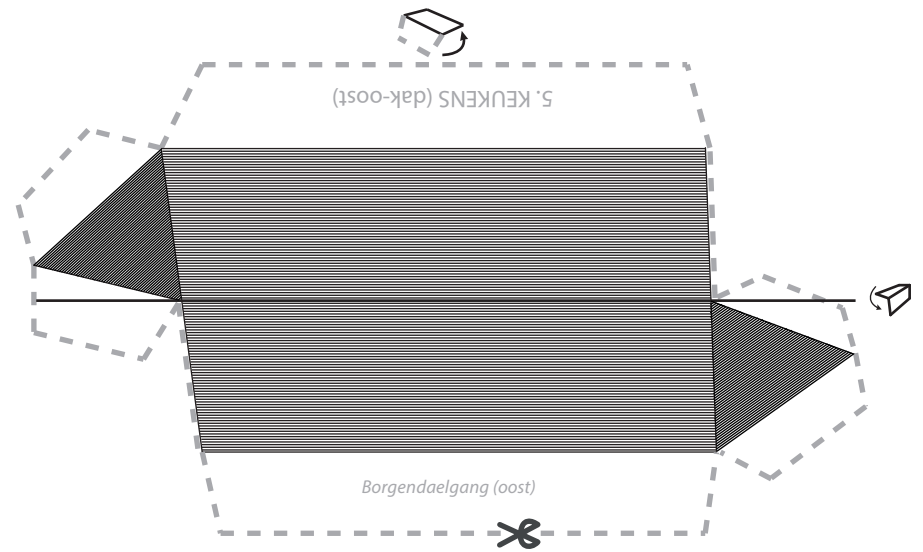

5.3 Dak (west)

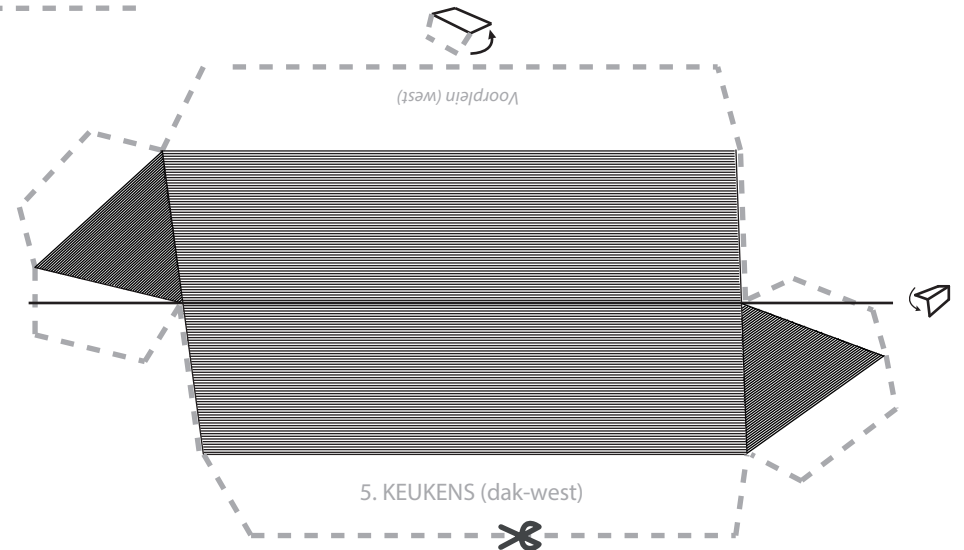

6. BORGENDAEL

